

.....

Pik Rite, Inc.

# Tomato Harvester

## Model: 240

# Operator's Manual 2012



August 2012

.....



60 PIK RITE LANE, LEWISBURG PA 17837

PHONE: 570-523-8174 FAX: 570-523-8175

EMAIL: [frontdesk@pikrite.com](mailto:frontdesk@pikrite.com) WEBSITE: [www.pikrite.com](http://www.pikrite.com)

---

Dear Customer,

Congratulations on purchasing a quality designed and manufactured Pik Rite tomato harvester!

You should expect a return on your investment in the form of excellent crop recovery, affordable parts and minimum maintenance.

Should your harvester need parts or service, we have a team that is fully equipped and committed to meeting your needs.

In order to maintain quality performance of your Pik Rite harvester, it is extremely important that all the information in the manual be reviewed and studied carefully before operation.

Thank you for buying a Pik Rite tomato harvester!

Sincerely,  
Elvin Stoltzfus, President

---

## **Company History**

---

Pik Rite, Inc. is a designer and manufacturer of innovative, quality-built vegetable harvesting equipment, ag manure spreaders, commercial waste handling equipment, and hydro seeding units. Located in Central Pennsylvania, Pik Rite operates from manufacturing facilities that encompass 33,000 square feet, in addition to office space utilizing an additional 2,700 square foot area. Elvin Stoltzfus and Joe Yoder, Pik Rite's original founders, have diverse backgrounds in farming and welding shop activities. Pik Rite was incorporated in July 1986 and presently employs approximately 35 people.

In 1983, the first tomato harvester was built for the purpose of providing a mechanical method of picking tomatoes. After a few years of testing and modifying the original machine, three Pik Rite harvesters were built in 1986. Pik Rite now holds a patent for a Double Brush Shaker System.

Since the 1990's, Pik Rite has experienced steady growth in sales, market coverage, and technological innovations. Pik Rite has subsequently developed and added equipment that can be used to harvest cucumbers, peppers, gourds, zucchini, squash, pumpkins and carrots. A vine windrower, which rearranges vines prior to picking, was developed in 1994. A new product to the marketplace - a plastic lifter/wrapper, was introduced in 1997.

Pik Rite initiated its product line diversification plans and began to manufacture commercial waste handling vacuum tanks in 1998. In 2000, Pik Rite introduced the Hydra-Ram Manure Spreader, formerly known as the John Deere Hydra-Push. A vine diverter, which is used to move the tomato crop from one row to the adjoining row, was first manufactured by Pik Rite in 2001. In 2002, Pik Rite sold its first HC290 tomato harvester, designed for the larger tomato grower.

A municipal leaf collection / compacting unit was added to Pik Rite's line of equipment in 2005. In an effort to maintain continual growth, Pik Rite manufactured and sold a carrot harvester in 2006. Also in 2006, Pik Rite introduced and sold hydro seeding units. Pik Rite strives to be a major contender in the field of hydro seeding equipment.

### **Markets**

Pik Rite, Inc. is currently selling its complete line of equipment throughout the United States and abroad, and is the preeminent seller of tomato harvesters and vegetable harvesting equipment in the Midwest and Eastern sections of North America, including Ontario, Canada. Machines are also presently being used to harvest a variety of crops in Southeastern US, Texas, New Mexico, California, Colorado, and Washington. In addition to the Canadian market, Pik Rite harvesters have also been exported to Russia, Australia, Mexico, Brazil, Israel, Turkey, Spain and Germany.

As the United States manufacturing sector enters the 21st century, Pik Rite continues to lead the way with the production of efficient, dependable equipment, which provides its customers with the best value for the dollar. In the agricultural area, the Commonwealth of Pennsylvania has recognized these efforts as Pik Rite, Inc. was presented with the state's Agribusiness Achievement Award in January 1997.

## - INTRODUCTION -



This safety alert symbol identifies important safety messages in this manual. When you see this symbol, be alert to the possibility of personal injury and carefully read the message that follows.

"Right-hand" and "left-hand" sides are determined by facing in the directions the tomato harvester will travel.

Record your tomato harvester serial number in the space provided below:

S. N. \_\_\_\_\_ Purchase Date

Please review the warranty for this tomato harvester which appears on the harvester order that was signed when the harvester order was placed. This warranty provides you the assurance that Pik Rite will back its products where defects appear within the warranty period. Pik Rite also provides field improvements, in some circumstances without charge to the customer, even if the product's warranty is expired.

Warranty and field improvements are a part of Pik Rite's product support program for customers who operate and maintain their equipment as described in this manual. If the equipment is abused or modified causing a change in its performance beyond the original factory specifications, the warranty will become void and field improvements may be denied.

For information and service call or write to:

Pik Rite, Inc.  
60 Pik Rite Lane  
Lewisburg PA 17837  
800-326-9763 (within the US)  
570-523-8174  
[www.pikrite.com](http://www.pikrite.com)

## NOTES

# - TABLE OF CONTENTS -

<b><u>COMPANY HISTORY</u></b> .....	<b>2</b>
<b>SECTION 1</b> .....	<b>7</b>
<b>SAFETY</b> .....	<b>7</b>
<b>SAFETY</b> .....	<b>7</b>
Recognize Safety Information .....	7
Understand Signal Words .....	8
Follow Safety Instructions .....	8
Operate Tomato Harvester Safely .....	9
Keep Riders Off Machine and Tractor .....	10
Prepare for Emergencies .....	11
Wear Protective Clothing .....	11
Protect Against Noise .....	12
Handle Chemical Products Safely .....	12
Stay Clear of Rotating Drive lines .....	13
Use Safety Lights & Devices .....	13
Use a Safety Chain .....	14
Reduce Speed When Towing Loads .....	15
Practice Safe Maintenance .....	16
Remove Paint Before Welding or Heating .....	17
Avoid Heating Near Pressurized Fluid Lines .....	17
Avoid High-Pressure Fluids .....	18
<b>NOTES</b> .....	<b>19</b>
<b>SECTION 2</b> .....	<b>20</b>
<b>PREPARATION, OPERATION &amp; MAINTENANCE</b> .....	<b>20</b>
<b>PREPARING THE TRACTOR</b> .....	<b>21</b>
2 - 1: Remove Tractor Drawbar .....	21
2 - 2: Power Take-Off Shaft .....	21
2 - 3: Hydraulic Power .....	22
2 - 4: Electrical Power .....	23
<b>PREPARING THE HARVESTER</b> .....	<b>26</b>
3 - 1: Unpacking the harvester .....	26
3 - 2: Oil Levels .....	26

3 - 3: Final Preparations .....	26
<b>OPERATING THE HARVESTER .....</b>	<b>28</b>
4 - 1: Starting Speed Settings .....	28
4 - 2: Disk Pickup Header.....	30
4 - 3: Header Chain .....	30
4 - 4: Powered Dirt Vibrators (Header & Transfer) .....	30
4 - 5: Primary Shaker .....	31
4 - 6: Secondary Shaker.....	31
4 - 7: Transfer & Cross Conveyor.....	32
4 - 8: Debris Fan.....	32
4 - 9: Elevation Conveyor .....	32
4 - 10: Presort Belt .....	33
4 - 11: Color Sorter.....	34
4 - 12: Hand Sort Belt.....	36
4 - 13: Discharge Conveyor.....	36
4 - 14: Vine Chain and Rear Transfer Conveyor .....	36
4 - 15: Hydraulic System .....	37
<b>MAINTAINING THE HARVESTER.....</b>	<b>38</b>
5 - 1: Cutting Disks .....	38
5 - 2: Gathering Chains .....	38
5 - 3: Header .....	39
5 - 4: Vibrators (Header & Transfer).....	39
5 - 5: Transfer Chain .....	39
5 - 6: Cross Conveyor .....	39
5 - 7: Primary Shaker .....	40
5 - 7a: Shaker Belt Tensioning Procedure .....	41
5 - 8: Secondary Shaker.....	42
5 - 9: Debris Elimination System .....	42
5 - 10: Presort Belt and Elevation Conveyor .....	42
5 - 11: Hand Sort Belt.....	42
5 - 12: Discharge Conveyor.....	43
5 - 13: Electro-hydraulic Valve & Control .....	43
5 - 14: Air Compressor (If Equipped with Air System).....	45
5 - 15: Vine Chopper (If Equipped).....	47
5 - 16: Suspension .....	47
5 - 17: Lubrication and Oils .....	48

5 - 18: Hydraulic Pump.....50  
5 - 19: Checklist.....53  
6 - 01: Header Height Set up procedure .....56

## Section 1 SAFETY

### SAFETY

---

The operator’s safety was one of the prime considerations in the minds of Pik Rite engineers when they designed the tomato harvester. Shielding, simple adjustments, and other safety features were built into the tomato harvester wherever possible.

**WARNING: Modifications to the tomato harvester may adversely affect its safety features as well as its efficiency and longevity.**

#### **Recognize Safety Information**

This is the safety-alert symbol. When you see this symbol on your machine or in this manual, be aware of the potential for personal injury.

**Follow recommended precautions & safe operating practices.**





### Understand Signal Words

A signal word—DANGER, WARNING or CAUTION—is used with the safety-alert symbol.

- DANGER identifies the most serious hazards.
- DANGER or WARNING safety signs are located near specific hazards. General precautions are listed on CAUTION safety signs.



### Follow Safety Instructions

**Carefully read all safety messages in this manual and on your machine safety signs.**

- Keep safety signs in good condition.
- Replace missing or damaged safety signs.
- Be sure that all new equipment components and repair parts include the current safety signs. *Replacement safety signs are available from Pik Rite.*
- Learn how to operate the machine and how to use controls properly.  
**CAUTION:** *Do not allow anyone to operate your machine without instruction.*
- Keep your machine in proper working condition. Unauthorized modifications to the machine may impair function and/or safety and affect machine life.

**NOTE:** *If you do not understand any part of this manual and need assistance, please contact your Pik Rite representative.*



## **Operate Tomato Harvester Safely**

All machinery must be operated by responsible persons who have been properly instructed and delegated to do so.

- Do not stand or work under discharge conveyor or header while harvester is operating.
- Do not stand between harvester and tongue while positioning tongue.

**WARNING: The harvester may move suddenly or fall while detaching. Use blocks under the wheels and release all stored energy from pickup float system before detaching harvesting unit.**

- Do not put hands or feet between tongue and frame opening while positioning tongue.
- Always operate machine at rated PTO speed.

**WARNING: To avoid injury or death, disengage drives, shut off engine, and make sure electrical power is off before servicing or unplugging the tomato harvester.**

- The disks and chains can feed tomato plants faster than you can release your grip on the plants.
- Do not use your hands or feet to feed plants into the harvester.
- Do not stand between tomato harvester and tongue when detaching harvester.

**WARNING: This tomato harvester is intended for mobile field operation only. Never use machine in a stationary position or modify it to be used as one.**

**WARNING: Keep away from Vine Chopper when running.**

**WARNING: Transportation Bars**

should be used on Steering axle and Leveling Cylinder during Transportation.

**Keep Riders Off Machine and Tractor**

- Allow *only* the operator on the tractor and *only* the laborers on either side of the Aftersort belt. Keep riders off.

**CAUTION:** *Workstations are built on the Pik Rite Tomato Harvester to ensure that laborers can safely stand while doing grading.*

- *Riders on machine are subject to injury such as being struck by foreign objects and being thrown off of the machine.*
- *Riders also obstruct the operator's view resulting in the machine being operated in an unsafe manner.*
- Service platforms are built on the Pik Rite Tomato Harvester to provide a suitable position from which to service the machine. These areas are not designed to be occupied during normal use of the machine.

**CAUTION:** *Service platforms are located before Color Sorter, above Debris area, and above Aftersort Belt. Riders on service platforms may be subject to injury.*

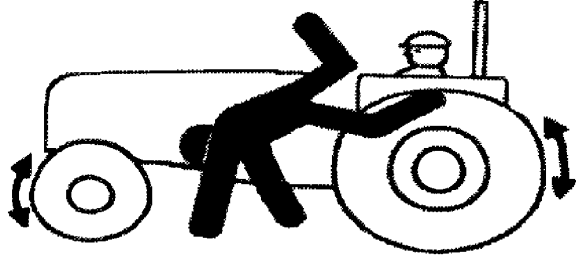

### Prepare for Emergencies

Be prepared if a fire starts.

- Keep a first aid kit and fire extinguisher handy.
- Keep emergency numbers for the ambulance service, hospital, fire department, and doctors near your telephone.

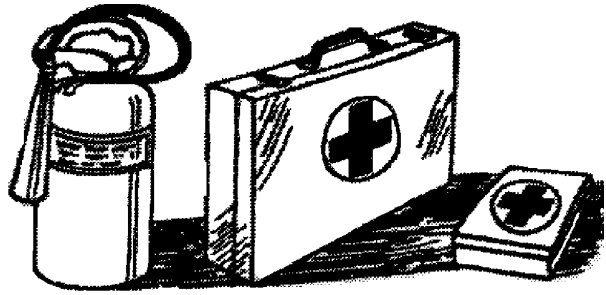

### Wear Protective Clothing

- Wear close fitting clothing and safety equipment appropriate to the job.

**CAUTION:** *Do not wear radio or music headphones while operating machine. Operating equipment safely requires the full attention of the operator.*

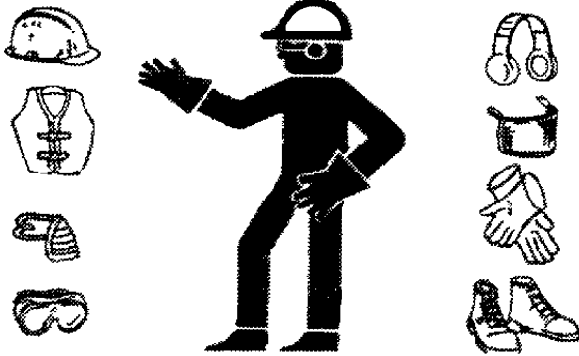

### Protect Against Noise

**WARNING: Prolonged exposure to loud noise can cause impairment or loss of hearing.**

- Wear a suitable hearing protective device such as earmuffs or earplugs to protect against objectionable or uncomfortable loud noises.

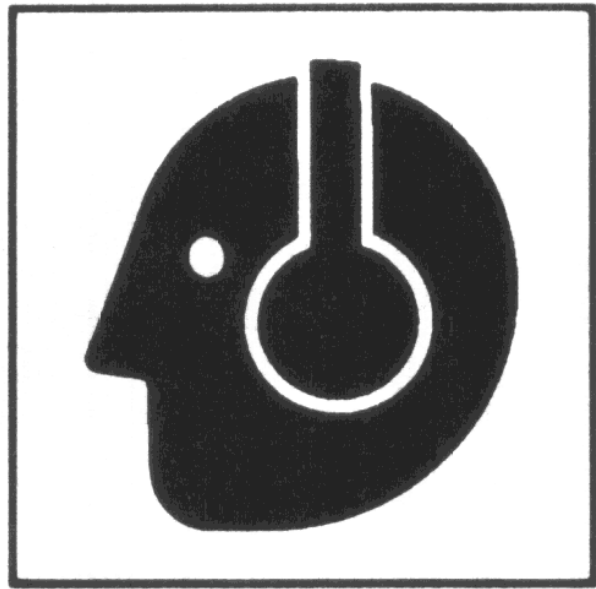

### Handle Chemical Products Safely

**WARNING: Direct exposure to hazardous chemicals can cause serious injury. Potentially hazardous chemicals used with Pik Rite equipment include *lubricants* and *paints*.**

- A Material Safety Data Sheet (MSDS) provides specific details on chemical products: physical and health hazards, safety procedures, and emergency response techniques.
- Check the MSDS before you start any job using a hazardous chemical. That way you will know exactly what the risks are and how to do the job safely. Then follow the advised procedures and make use of the recommended equipment.

**NOTE:** Contact the Pik Rite Lewisburg, PA office for MSDSs on chemical products used with Pik Rite equipment.

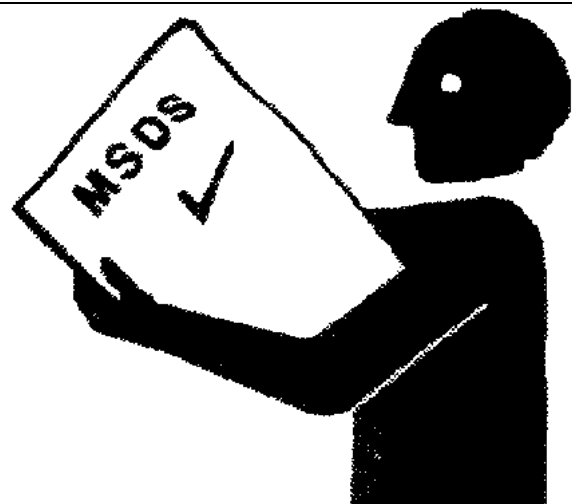

### Stay Clear of Rotating Drive lines

**WARNING:** Entanglement in rotating driveline can cause serious injury or death.

- Keep the tractor master shield and drive line shields in place at all times. Make certain that rotating shields turn freely.
- Wear close fitting clothing. Stop the engine and be sure that the PTO drive line is stopped before making adjustments, connections, or cleaning out the PTO-driven equipment.



### Use Safety Lights & Devices

**WARNING:** Slow moving tractors and towed implements are difficult to see, especially at night, and may create a hazard when driven on public roads.

*Avoid personal injury or death resulting from collision with a vehicle.*

- Use flashing warning lights and turn-signals when driving on public roads.
- To increase visibility, use the lights provided with your machine.

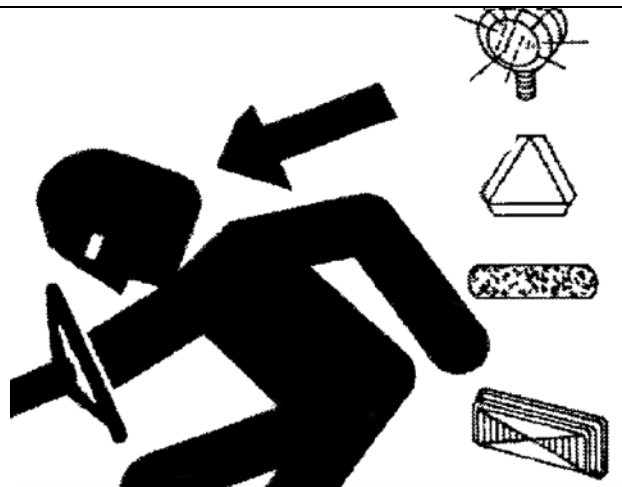

### **Use a Safety Chain**

A safety chain will help control drawn equipment if it accidentally separates from the drawbar.

- Attach the chain to the harvester main frame and the tractor drawbar support or another specified anchor location. Provide only enough slack in the chain to permit turning.
- Use a chain with a strength rating *equal to or greater than the gross weight of the tomato harvester* (approximately 24,000 lbs.).

**CAUTION:** *Do not use the safety chain for towing.*

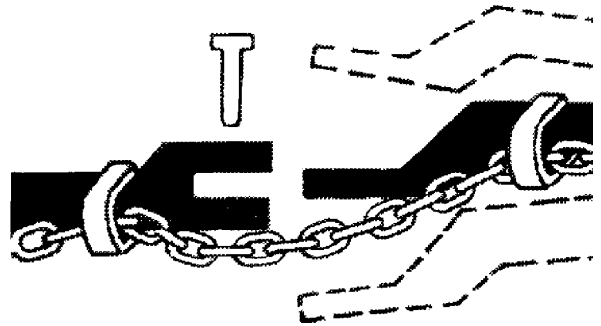

## **Reduce Speed When Towing Loads**

**DANGER: Braking to stop towed loads from transport speeds can cause the towed load to swerve and upset. Reduce speed if towed load weighs more than the tractor and/or the tractor is not equipped with brakes.**

Follow recommended speed-weight ratio guidelines:

- Maximum speed is 20 mph (32 km/h) when towing a load equal to or less in weight than the tractor.
- Reduce speed to 10 mph (16 km/h) when towing a load up to double the tractor weight.
- Do not tow loads exceeding double the tractor weight.
- Use additional caution when towing loads under adverse surface conditions, when turning, and on inclines.

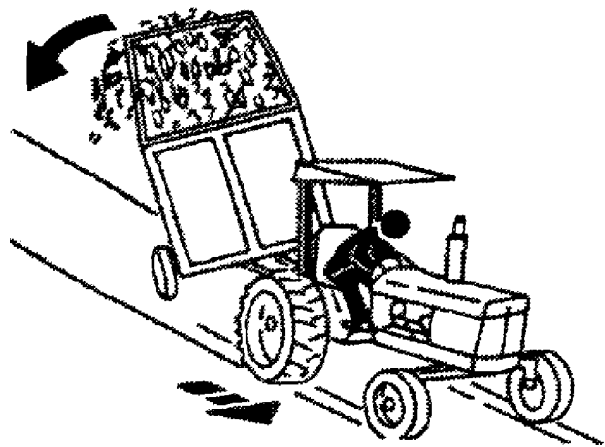



## **Practice Safe Maintenance**

Understand service procedure before doing work. Maintain cleanliness and dryness in work area.

- Never lubricate or service the machine while it is in motion.

**WARNING: Be sure to keep hands, feet, and clothing away from power-driven parts.**

1. Disengage all power and manipulate controls to relieve pressure.
  2. Lower equipment to the ground.
  3. Stop the engine.
  4. Remove the key.
  5. Allow machine to cool.
- Securely support any machine elements that must be raised for service work.
  - Keep all parts in good condition and properly installed. Fix damage immediately. Replace worn or broken parts. Remove any buildup of grease, oil, or debris.
  - Disconnect battery ground cable (-) and unplug main power supply cord on sorter before making adjustments on electrical systems or welding on machine.



### **Remove Paint Before Welding or Heating**

**WARNING:** Avoid potentially toxic fumes and dust. Hazardous fumes can be generated when paint is heated by welding, soldering or using a torch.

- Do all work outside or in a well-ventilated area. Dispose of paint and solvent properly.
- Remove paint before welding or heating.
- If you sand or grind paint, avoid breathing the dust. Wear an approved respirator.
- If you use solvent or paint stripper, remove stripper with soap and water before welding.
- Remove solvent or paint stripper containers and other flammable material from the area.
- Allow fumes to disperse at least 15 minutes before welding or heating.

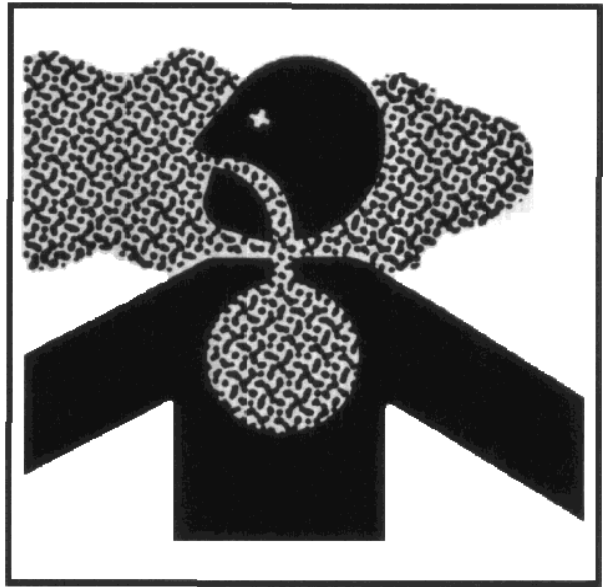

### **Avoid Heating Near Pressurized Fluid Lines**

**WARNING:** Flammable spray can be generated by heating near pressurized fluid lines, resulting in severe burns to you and bystanders.

- Do not heat by welding, soldering, or using a torch near pressurized fluid lines or other flammable materials. Pressurized lines can be accidentally cut when heat goes beyond the immediate flame area.



### Avoid High-Pressure Fluids

**WARNING: Fluid escaping under pressure carries the potential to penetrate the skin resulting in serious injury.**

- Avoid this hazard by relieving pressure before disconnecting hydraulic or other lines. Tighten all connections before applying pressure.
- Search for leaks with a piece of cardboard.
- Protect hands and body from high-pressure fluids.
- If an accident occurs, see a doctor immediately.

**WARNING: Any fluid injected into the skin must be surgically removed within a few hours or gangrene may result. Doctors unfamiliar with this type of injury should reference a knowledgeable medical source.**



## NOTES

---

**Section 2**  
**PREPARATION, OPERATION & MAINTENANCE**

---

# PREPARING THE TRACTOR

---

## **2 - 1: Remove Tractor Drawbar**

The harvester is attached to the 3 point arms. When the tractor is shut down, it is best to remove the drawbar to avoid damage to the PTO shaft when the arms drift down.

The harvester is designed to use either Category 2 Heavy duty or Category 3 and most of the “quick attach” designs associated with Category 3. 1-7/16” pins are supplied with the machine. The top link of the 3 point tractor system is not used however when using “quick attach” systems. The top adjusting arm may need to be adjusted all the way in (shortest position). This will avoid interference of the top hook with the machine’s hydraulic hoses.

The sway blocks on the tractor 3 point arms must be adjusted to ½” or less sway when attached to the harvester. Shims can be placed on the 1-7/16” connecting pins of the machine or the tractor manufacturer can supply the proper sway blocks. The maximum measurement on the harvester at the 1-7/16” pins is 44.00 inches and the minimum is 32.00 inches. After the proper adjustments to the 2 arms and the safety bolts are secured on the 1-7/16” pins, the machine can be lifted by raising the 3 point arms.

## **2 - 2: Power Take-Off Shaft**

The tractor must have a PTO speed of 1000 RPM to match the power shaft speed of the harvester. The harvester can operate between 600 RPM (min.) and 1000 RPM (max.). Optimum speed is 850 RPM. That generally means operating the tractor engine at 1600 - 2200 RPM. [Note: This is assuming that Pumps, Motors, and other Components are NOT excessively worn (after hours of use) and are operating correctly.] PTO energy consumption is at approx. 135 HP at 1000 RPM. A 190 HP tractor is the minimum required.

The Pik Rite harvester uses a 1-3/4 - 20 spline PTO yoke.

1. Before attaching the PTO to the tractor, be sure that the shaft is greased & can slide freely in the tube.
2. Attach the PTO to the tractor.
3. Be sure that the PTO lock pin or latches are securely locked into the tractor's PTO shaft.
4. For longer PTO life, it should operate in the straightest position possible. However it can be operated safely with the rear PTO yoke approx. 3” lower or higher.



**CAUTION:** The machine operator must be aware of the height of the 3 point arms and be within this range or damage may occur to the PTO shaft.

## **2 - 3: Hydraulic Power**

The Pik Rite harvester relies on the tractor hydraulics to control the machine cylinder functions. A valve body located on the machine is equipped with an in-and-out hose that must be connected to the hydraulic outlets at the rear of the tractor.

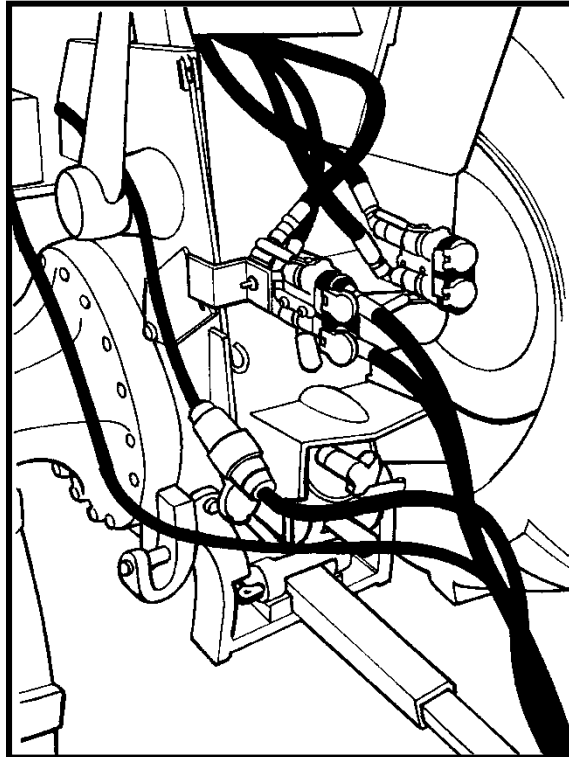

In order to make the harvester compatible with any brand of tractor\*, Pik Rite designs the harvester for operation in the *continuous flow mode*. This allows the farmer to use any brand of tractor\*. The Pik Rite Tomato Harvester requires a...

- Minimum of 12 gallons per minute & 2500 PSI
- Maximum of 18 gallons per minute & 3000 PSI
- The back pressure of the return line should not exceed 200 PSI

Follow the tractor manufacturer's instructions for:

### **CONNECTING AN ORBITAL HYDRAULIC MOTOR**

Connecting a hydraulic motor is identical to connecting the hydraulics to the Pik Rite Tomato Harvester.

## **2 - 4: Electrical Power**

The Pik Rite Harvester relies on the tractor's electrical system. At the minimum, a 150-amp alternator is required to keep the voltage constant during night-time operations. Operating during the day without the lights requires less amperage. There is one electrical hook up to the tractor. Hooking up to the battery is necessary to operate the electronic color sorter and sorting lights. The hook up is directly to the battery through the breaker box and then into a 7 pin plug to the Harvester.

**WARNING: This must be hooked up to the battery. The battery acts as a filter for more harmful AC Volts. AC Volts will damage the color sorter computer.**

With the tractor engine running at PTO speed, and lights, air conditioner, and other high Volts/Amp components switched ON, check the voltage at the battery. The voltage should be between +12.5 Volts D.C. to +14.5 Volts D.C.

Also check for AC current. This must not exceed .05 Volts AC Voltage above this indicates that the "Ground" to the battery may be faulty and/or NOT functioning properly or the tractor alternator has a bad rectifier & needs replacement.



**CAUTION:** *Be sure the electronic color sorters are UNPLUGGED before hooking harvester power supply to battery.*

Before connecting power plug at the electronic box, check polarity at plug on electronic sorter (if polarity is wrong, it may burn out the box):

White wire = A = Positive-with red probe.

Black wire = B = Negative-with black probe.

With tractor running at about 1800 RPM and **before plugging into box**, insert the tester probe: positive in A and negative in B terminal:

- Voltage needs to be between +12.5 to +14.5 Volts D.C.
- If a negative figure is displayed in the test, the polarity is reversed.
- Check for AC Volts; .05 AC Volts is the maximum allowed.

**WARNING: Anything over .05 AC Volts alternator must be changed. This condition indicates that the alternator will soon fail, a condition detrimental to the Odenberg Electronic Box.**

- A *Fluke meter* is the preferred tester, accurate enough to test AC stray voltage.





**CAUTION:** *The power supply wire must be connected at the battery. The battery acts as a filter for harmful voltage spikes which will damage the electronic sorters. Hooking the power cord incorrectly can cause damage.*

### **12-volt battery**

1. Attach the Black & White wire to the positive terminal. Wires are dictated with a red marker on the wires.
2. Attach the Green wire to the negative terminal. Wire is marker with a black marker on the wires.

### **Other Electrical Preparations**

#### **1. Shaft monitors (optional)**

##### Operation:

When all the shafts are stopped, the alarm will not sound. Similarly, when all the shafts are running, the alarm will not sound. Only if some, but not all, of the shafts are running will the alarm sound.

When one of the shafts stops, there will be a delay of up to 3 seconds before the alarm sounds. This is due to two separate delays. First, the minimum acceptable shaft speed is set at 10 RPM, which means it can take up to 1.5 seconds between pulses from the shaft sensor. Once this 1.5 second time has elapsed, the Shaft Monitor waits another 1.5 seconds before sounding the alarm to see if the rest of the shafts are also stopping. This avoids nuisance alarms when the machine is shut down.

When the alarm sounds, it will be in various pulses. 4 beeps indicate that the elevation conveyor is stopped. 3 beeps indicate that the cross conveyor is stopped. 2 beeps indicate that the vine chain is stopped. And 1 beep indicates that the transfer chain is stopped.

##### To trouble shoot the magnetic sensors:

The magnetic sensors located at the various shaft locations must be 1/8" clearance between the rotating magnet and the stationary plastic sending unit.

By observing the L.E.D lights inside the control box (in the tractor cab) one can trouble shoot the wiring and the magnetic sensor functions. The blinking L.E.D light indicates an electric pulse is being sent and received. A steady on light indicate improper sensor clearance or a broken wire. A steady off light could indicate a broken wire or a defective board.

**2. Auto Height Sealed Rotary Sensor centering controls**

**3. Optional Speed Controls for Various Conveyors**

This option allows speed control of various conveyors and components from the tractor seat.

# PREPARING THE HARVESTER

---

## **3 - 1: Unpacking the harvester**

1. Slide and unfold the outside deck and secure.
2. Install the hand rail.
3. Assemble debris belt and air deflector components.
4. Activate the bottom discharge cylinder, thus creating the “basket” storage area. Be sure the basket sides are in proper place and the discharge conveyor chain flights pass throughout this area properly.
5. Slide the Aftersort Table forward to harvest position

## **3 - 2: Oil Levels**

1. Be sure the main hydraulic reservoir is above the low line on the level / temperature indicator located at the rear of the reservoir.
2. Check to be sure that the pumps of the air compressors are full as indicated on the dipsticks/plugs located on the bottom rear of the air compressor.
3. Check oil in the 2 pad gear box on the Dipstick.
4. Turn all of the flow controls to the off position (Pointed at 0). There are approx. 17 controls, depending on how the machine is equipped.

## **3 - 3: Final Preparations**

1. Start the PTO at low RPM.



**CAUTION:** *Always have a tractor operator on the seat and prepared to disengage the PTO when making the following observations and flow control adjustments.*

2. Check for oil leaks in the event that a hydraulic fitting is loose or broken.
3. Check to be sure that the oil cooler fan located on the top of the machine is turning counterclockwise therefore blowing air upward.
4. If the harvester is equipped with a sorter, be sure that the air dryer and air compressor unload after about 2 - 3 minutes of running the PTO at low RPM. This unloading is indicated by a loud hiss of air, a change in the sound of the air compressor, and the indicator light goes off. The air pressure will be at approx.

100 PSI and remain in this unloaded state until the tank pressure drops to about 80 PSI, after which the compressor will again begin pumping air and the indicator light will go on until the maximum is reached, a loud hiss of air is again heard and the indicator light goes off.

5. One by one, open each flow control to the #1 position and observe how it functions. Be sure the component runs freely and without misalignment.
6. Slowly increase the speed to the desired setting. Later, while in actual field conditions, fine adjust to meet requirements.

# OPERATING THE HARVESTER

---

**CAUTION:** *Operating the Pik Rite Harvester requires much attention to detail. The operator must remain attentive to avoid injury to the crew or damage to the machine!*



**DANGER:** To preserve life and limbs of crew cleaning the machine, the tractor operator must always warn them before engaging the PTO.

- This warning needs to be understood by all crew members.
- The harvester comes equipped with an alarm on the harvester and in the operator's Control Box (in the tractor).
- Operators should sound the Alarm or a signal from the tractor when ready to start and then wait for an "all clear" response from the crew before engaging the PTO.
  - Crew members working on the harvester should sound the Alarm by pulling on Alarm Cord, located directly above the sorting area, to inform the operator and/or other crew member of Danger

## 4 - 1: Starting Speed Settings

Speeds of conveyors and components will vary a great deal with field conditions. There is no prescribed speed at which to set the flow controls. However, there is an approximate start-up setting, and the operator needs to adjust as needed for conditions.



**CAUTION:** *Never leave the machine running while getting off the tractor and adjusting the speed setting. Unless a technician on the machine is prepared to make the adjustment while running, always stop the PTO while making adjustments.*

The Pik Rite Harvester may be operated at a maximum speed of 1000 PTO RPM or a minimum of 600 (Ideal field & harvester conditions) PTO RPM.



**CAUTION:** *Idle the tractor down to engage and disengage the PTO. If the PTO is engaged or disengaged at high RPM, the pressure spikes may cause unnecessary wear to the hydraulic pump.*

Speed control valves control all of the hydraulic motors except the cooling fan motor. These valves control speed by monitoring the amount of oil that is allowed to pass through the motor. The unused oil is passed around the motor. Both the bypassed oil and the oil that has passed through the motor flow together down-line to the next flow control valve, where the process is repeated.

- There are six pump sections; hence there are six hydraulic circuits (Excluding the hydraulic lift cylinder circuits). Each circuit has three to seven motors running in series.
- The pump is a *constant displacement* pump, which means that when the PTO is engaged, each section is pumping approx. 12 or 24 GPM, depending on the gear width and PTO RPM. It pumps the same amount of oil at high or low pressures. Consequently, the pumped oil must always have a channel to return to the reservoir because it is constantly moving through the circuit.
- Five of the six circuits empty into the oil cooler (mounted on top of the machine), are cooled, and sent through the filter back to the oil reservoir. The remaining circuit empties into the return line just before the filter and then flows into the oil reservoir.
- Because the hydraulic motors are controlled by flow control valves, operating the tractor at higher RPM speeds will not necessarily result in faster operation of the harvester. *Higher operating speed is obtained by setting the flow control lever to a higher number.*
- Ideally, the operator should set the flow controls to the desired speed and match the tractor RPM to the amount of oil required. Higher engine speed only causes more oil to bypass the motor, resulting in a waste of energy, more heat in the system, more wear, and general inefficiency.

The estimated start-up settings are as indicated in chart 4A. They are given in number of rotations from the closed position and in inches of threads showing above the jamb nut. (i.e. 4 Rotations – ¼”)

**Chart 4A**

**Flow control setting**

Disk Pickup Header	10
Header Chain	10
Powered Dirt Vibrator	5
Primary Shaker Rotator	1
Secondary Shaker Rotator	1
Primary Shaker Weights	5
Secondary Shaker Weights	5
Transfer/Cross Conveyor	5.5
Debris Fan	5.5
Elevation Conveyor	5.1

**NOTE:** More detailed settings are described in the following sections.

Presort Belt (See Sec. 4.10)	Tach.
Hand Sort Belt	5
Discharge Conveyor	5
Debris Conveyor	3-4
Vine Chain	3.5
Vine Chopper	Tach. Approx. 800-1200 rpm

#### **4 - 2: Disk Pickup Header**

**It is important to keep a steady-to-thin flow of tomato plants through the header.**

- The Disk Pickup Header is to skim the ground just under the tomato plants taking in as little of dirt/mud as possible without product loss.
- Each gathering disk is independently controlled and thus the header flexes from side to side controlling the depth of each disk independently. *The operator must watch closely and control both the right and left gathering disks.*



**CAUTION:** *The header on your machine has been designed to flex for better operations. However, flexing the head in excess will cause stress and premature damage to your machine.*

- *The maximum difference from side to side should not exceed 6 inches.*
- *To avoid uneven drifting of the hydraulics, rest the header on the ground when parking the machine.*

#### **4 - 3: Header Chain**

Normally, the flow setting is wide open. This keeps a thinner flow of vines and dirt running over the vibrator and also helps to eliminate the dirt. *If fruit loss occurs under the header sprockets at the feeder roll, slowing the header chain and/or adjusting the (2) 4" rollers (on the return side) will help.*

#### **4 - 4: Powered Dirt Vibrators (Header & Transfer)**

As the vines and tomatoes travel up the header chain, they go through the dirt vibrator tunnel (or the Overhead Vine Assist Option). The operating speed of the vibrator varies according to field conditions and vine mass. Some conditions such as working with thin vines require little or no vibration. Heavy vines, though, will require higher vibrator speeds.

**CAUTION:** *The operator must prevent rollback or bunching of the vines as well as over-speeding the vibrator. The bunching of vines results in inefficiency and fruit loss as*

*it passes through the harvester. Over-speeding the vibrator causes excessive wear to the header chain and vibrator rollers.*

#### **4 - 5: Primary Shaker**

The Pik Rite Harvester is designed to allow the operator to observe the rotation and movement of the *primary and secondary shakers* from the tractor seat. There are two points of control on these shakers: 1) weight speed and 2) rotation speed.

1. The weight speed controls the *intensity* of the shake (more RPM = more vigorous shake).
2. Rotation speed controls the *speed* of the entire shaker drum, thus controlling how long the vines remain on the shaker. With slower rotation speeds, the tomato vines take longer to ride over and out of the shaker.
3. Initial start settings: for primary weights, set flow control in middle. For primary rotation of drum, begin at one revolution every 10-12 seconds or 5 to 6 RPM.

#### **Special Conditions**

Conditions vary drastically according to the field, the day, and the variety of tomato plant. By keenly observing the shaker and outflow of vines, the operator will learn very quickly how and when to make minor adjustments.

- In viney weed conditions (morning glory), slow the shaker rotation.
- In heavy tomato vines increase the primary shaker rotation speed, thus keeping a thinner layer of vines on the shaker.
- Regularly clean the dirt build-up from the shaker drum & side panels.

Primary Shaker Hood: Generally, the hood must be very close ( $\frac{1}{2}$ " to 1") to the shaker tines; some conditions require it to be lifted 3 to 4 inches higher.



**CAUTION: Never allow the hood to operate while touching the tines. This will wear both the tines & hood prematurely.**

#### **4 - 6: Secondary Shaker**

Generally, the *secondary shaker* weight speed is greater than the primary shaker weight speed.

**CAUTION:** *If the secondary shaker rotation speed is too high, it may cause dragging under or wrapping of vines, etc. around the drum. For optimum performance adjust the rotation speed according to the speed of the Vine Chain.*

For additional information, refer to the preceding item.



#### **4 - 7: Transfer & Cross Conveyor**

These conveyors are hard to see from the tractor seat but generally require little or no attention. Nevertheless, be aware of these suggestions:

- There is a pipe roller under the drive end of both of these conveyors. These rollers are equipped with scrapers on the bottom side to keep them clean. The operator should regularly clean the pinch point between the roller and scraper.

#### **4 - 8: Debris Fan**



**CAUTION:** *It is possible to over-speed the debris fan when operating high tractor PTO RPM.*

- Operate the *debris fan* at a speed that satisfactorily removes the vines and debris. *Do not over-speed or damage may occur.*
- The operator can see from the tractor seat if all is well with the debris removal system and should regularly observe it as he travels down the row.
- Dirt buildup must be removed to keep the fan efficient.

#### **4 - 9: Elevation Conveyor**

- The elevation conveyor belting chain may be adjusted to more or less an angle of incline by moving the nose rollers (at rear of presort belt) to desired height and then adjusting the belted chain roller to avoid sags or humps.

## **4 - 10: Presort Belt**

- Proper tension of the presort belt is as shown:

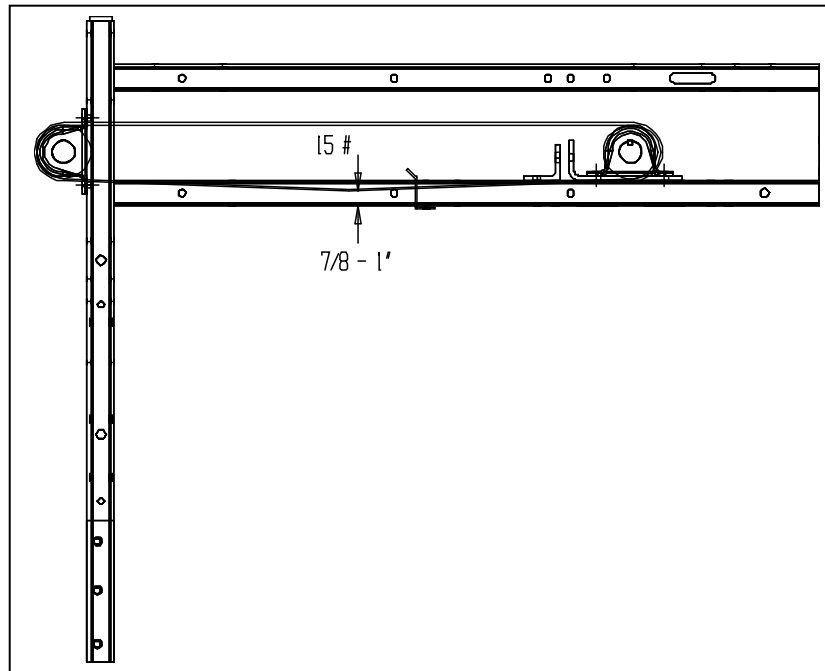

- **Observing the presort belt.** The *presort belt* is very important, and must run freely and smoothly. Operating under normal conditions it should be *full and one layer deep*, with the tomatoes spread evenly across the entire conveyor.

**CAUTION:** *If the belt is half full, the electronic sorter becomes inefficient. Stacking or crowding the tomatoes as they pass through the electronic sorter will result in loss of fruit.*

- **Leveling the machine.** If the tomatoes are crowded to one side, the machine must be adjusted at the “Auto Level Control”. Loosen the (2) bolts/nuts at the “Auto Level Control” to achieve the level needed. The “Auto Level Control” has a (2) second delay which necessitates having it in the correct position for a time before securing the (2) bolts/nuts. The operator can observe the tomatoes when they pass through the electronic sorter and drop onto the hand sort belt. There should be an even steady flow of fruit at this point also. The operator then determines the ground speed.

## **SETTING BELT SPEED**

Method # 1: Use a belt tachometer to set the belt speed. For Grademaster, the speed should be 33 1/2 RPM, or 200 ft. per. minute.

Method # 2: Place a white mark on the belt and count the number of belt revolutions in one minute. The presort belt is 6 ft. and 1/4 in. long. Simply multiply belt revolutions per minute by 6 to calculate speed of belt (i.e. 34 RPM X 6 = 204 FPM).

**NOTE:** It is essential to adjust the positions of the electronic sorter rejecter fingers when adjusting the belt speed.

#### **4 - 11: Color Sorter**

The *color sorter* instructions are covered in a separate manual, but here are a few important details:

- The Pik Rite Harvester relies on the tractor's electrical system. At the minimum, a 150-amp alternator is required to keep the voltage constant during nighttime operations.
- Operating during the day without the lights requires less voltage.

**CAUTION:** *The color sorter must be hooked up to the battery. The battery acts as a filter for more harmful AC Volts. AC Volts will damage the color sorter computer.*



**CAUTION:** *Be sure the electronic color sorters are UNPLUGGED before hooking harvester power supply to battery.*

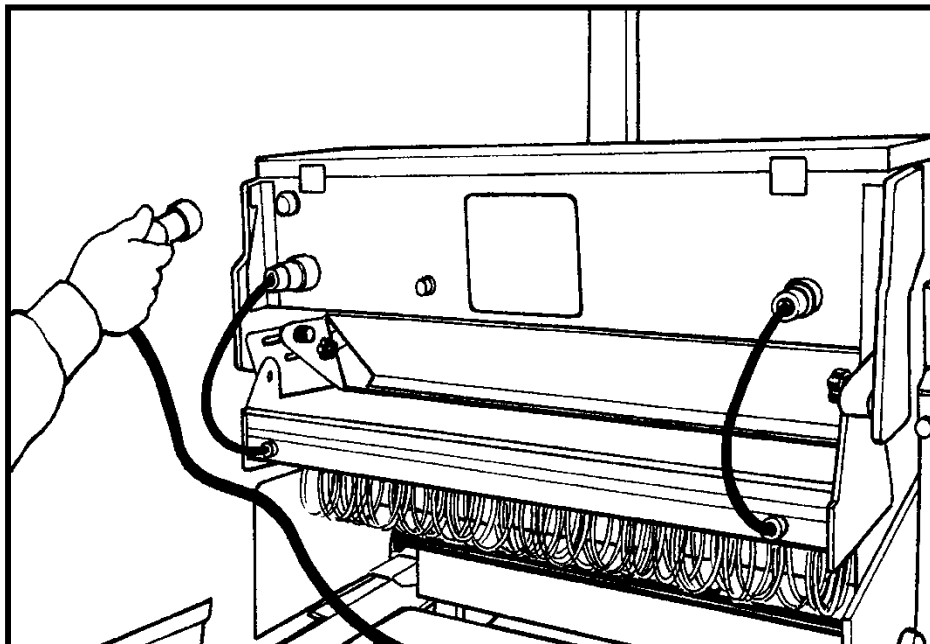

- Before connecting power plug at electronic box, check polarity at plug on electronic sorter (if polarity is wrong, it may harm the electronics):

- √ White wire = A = Positive-with red probe.
- √ Black wire = B = Negative-with black probe.

- With tractor running at approx. 1800 RPM and *before plugging into box*, insert the tester probe: positive in A and negative in B terminal:
  - √ Voltage needs to be between +12.5 to +14.5 Volts D.C.
  - √ If a negative figure is displayed in the test, the polarity is reversed.
  - √ Check for AC Volts; .05 AC Volts is the maximum allowed.
- Type of tester preferred: A Fluke meter has been found to be accurate enough to test AC stray voltage.

**CAUTION:** *Anything over .05 AC Volts alternator must be changed. This condition indicates that the alternator has faulty or improper components and is detrimental to the Odenberg Electronic Box.*

Check all of the above tests with the night-lights on also.

**CAUTION:** *The power supply wire must be connected at the battery. The battery acts as a filter for harmful voltage spikes, which will damage the electronic sorters.*



- Air pressure should be 60 PSI at the FRL (located beside the color sorter) for the Grademaster.
- Oiler should deliver 6 drops of oil per minute when the sorter is at work sorting tomatoes. It is adjusted on top of the FRL.
- Two bowls are located on the FRL. The oiler bowl needs to be filled with electronic sorter oil (see electronic sorter manual); the other bowl is a water trap. Normally, no water is in it because the air dryer has trapped all of it.
- Grademaster Sorter: Rejected fruit should travel *slightly downward*, perpendicular to the rejecter fingers.
  - √ If it travels *upward*, the delay from the time that it sees the tomato until it is rejected is too SHORT.
  - √ If the rejected tomato travels downward, the delay is too LONG.
 

**NOTE:** This applies to rejected green tomatoes only. Rocks and dirt will not be rejected in this way, but will often travel in a downward angle due to the weight.
- The electronic sorter should not look at the belt. It should focus 1/4" - 3/8" just under the belt. Adjust the box to conform to these measurements. Be sure to check both sides of the belt.



**CAUTION:** *Be sure all other mount measurements are correct. Before adjusting the box angle, refer to electronic sorter owner's manual.*

For *Grademaster sorters* the measurement should be 2" between tomatoes and rejecter fingers at tips while tomatoes are being run through the machine. Check this measurement by sighting from the side of the flow of tomatoes. Corrections can be made to the rejecter position after the proper belt speed is assured.

#### **4 - 12: Hand Sort Belt**

Operate the *hand sort belt* fast enough to keep the tomatoes from stacking. The operator should determine belt speed-- he can see the entire machine and may need to speed up when the fruit flow is heavy.

**CAUTION:** *Because of motion sickness, etc., excessive belt speed may cause illness among the sorters.*

#### **4 - 13: Discharge Conveyor**

The *discharge conveyor* consists of four parts: the *outer link*, *middle link*, bottom discharge and *basket* (bottom part where tomatoes drop into from the hand sort belt).

When the tomato flow is heavy, the *middle link* should be as close to the truck or as low as possible to prevent fruit from rolling back and bouncing over the side. The *basket* can be used to retain tomatoes until a truck can be positioned under the conveyor.

**NOTE:** By turning the discharge conveyor off, the operator can save time because he doesn't need to empty the machine at the end of each row; instead, he can begin harvesting the next row while the truck is being positioned properly.

**CAUTION:** *The operator must pay close attention to the truck being pulled alongside the harvester. The discharge conveyor can be bent and rendered useless in a very short time if it is left unattended.*

#### **4 - 14: Vine Chain and Rear Transfer Conveyor**

These two conveyors in the shaker chamber work together to provide better separation of product and vines. The wide spacing of the bars, of the Vine Conveyor, allows product to fall from among the vines as soon as separated by the Primary Shaker and also around the Secondary Shaker. Operate the Vine Chain at a speed as to keep a consistent thin flow of vines flowing through the shakers.

#### **4 - 15: Hydraulic System**

The operator should periodically observe the normal running pressures of the hydraulic pumps as he moves down the row. A high-pitched squeal (Flow Control with Relief) or hissing sound indicates that a relief valve in the hydraulic system is opening because a conveyor or other component has stalled out. By installing a pressure gauge at one of the test ports and using the process of elimination, the operator can identify the problem component. When a jam-up occurs, the motors require more power and thus the pressure gauge registers more pressure.

To avoid problems:

- Keep oil cooler fans clean. Check weekly.
- Maintain hydraulic oil temperature at 150-160 degrees.
- Keep hydraulic oil level within 10" of top of reservoir.
- Change hydraulic oil filters each season. Check for water in oil by removing the magnetic plug at bottom of the reservoir. Also check for wear metals. Test Kits are available from your Pik Rite Dealer.

## MAINTAINING THE HARVESTER

---

*Preventative maintenance is better than emergency repairs.*

### **5 - 1: Cutting Disks**

Standard *cutting disks* measure 34" in diameter when new. Install a new pair when they wear to 33" diameter. The life of these disks varies greatly with soil types and the operating RPMs.

**NOTE:** At your dealer you will find 36" diameter disks, which may or may not work better in your field conditions.

### **OPERATING AND MAINTENANCE TIPS:**

- When harvesting on elevated beds, you may want to lengthen the gathering chain in order to "reach down" into the trenches and pull the tomatoes into the machine (additional chain length will need to be added).
- The nose cones of the gathering chains should not plow dirt. In elevated beds, the noses need to extend down into the furrows and lift the vine.
- Adjust the disk scrapers to eliminate dirt build up.

### **5 - 2: Gathering Chains**

- Be sure the lap splice belts are not broken or worn.
- Keep the belt tension just tight enough to running smoothly--free and straight.

**CAUTION:** *Over-tensioning will wear all components prematurely.*

- Keep grass and vines from wrapping on drive sprockets and clean the build up at the pinch points. Grass and vines that wrap around the shafts at the bearings will damage the bearing seal and cause the bearings to fail.

### **5 - 3: Header**

- Clean out build-up at pinch points.
- Check bolts on lap splices of header conveyor and gathering chains. These bolts, when dragged through the dirt and rocks, sometimes wear off prematurely.
- Lube roller chains daily (Conklin Lube Oil is recommended).
- Grease bearings once a week. You will find two grease fittings on the bearings of the drive shaft.

**REMINDER:** When harvesting in rocky fields, increase the clearance between the bottom of the disks and the top of the header chain by adjusting the header chain nose rollers down. This greater clearance allows rocks to pass around the nose rollers without pinching the header chain and disks.

### **5 - 4: Vibrators (Header & Transfer)**

The *vibrator* is an effective, high-wear tool. Use it with discretion, adjusting speeds to match the requirements of the job.

- Check regularly for loose or lost rollers.
- In the vibrator area, you will find *four* rollers. These rollers, which are adjustable in height, carry the weight of the chain.

**CAUTION:** *If the vibrator shaft rollers are too low, they will hit the conveyor chain too hard and cause rotating difficulty, especially if operating at low RPMs.*

### **5 - 5: Transfer Chain**

Check drive sprockets and lap splice bolts or clips for wear. Keep Return Roller area free of excessive mud and debris to avoid premature wear to the Roller, Chain bars and Clips, and to avoid restrictions of the air flow at the Debris Fan outlet.

⇒ There is an optional vibrator kit for the Transfer. See 5-4 for operating information.

### **5 - 6: Cross Conveyor**

Check drive sprockets and lap splice bolts or clips for wear. Keep Return Roller area free of excessive mud and debris to avoid premature wear to the Roller, Chain bars and Clips, and to avoid restrictions of the air flow at the Debris Fan outlet.



## **5 - 7: Primary Shaker**

The *primary shaker* is important in...

- Keep shaker drum clean.

**NOTE:** In some ground conditions, dirt builds up between shaker tine groups on the drum. This build up should not exceed 1" in thickness. Also, dirt builds up on the side of the shaker chamber. If not removed, it will wear flat spots on the outside shaker tines. Remove this dirt with a scraper.

- Always replace broken tines as soon as possible. The shaker loses efficiency when tines are broken.

**NOTE:** Before installing a new tine, be sure that the hole in the rubber holder is clean and free of dirt.

- When installing the new tine be sure to prevent the inner fiberglass rod from sliding into the rubber holder without the plastic coating.
- The primary shaker can be adjusted either forward or backward from the header chain.

**NOTE:** If harvesting in rocky fields, the gap should be widened to help avoid broken shaker tines. However, if the gap is widened too much, some plant varieties tend to fall down in front of the shaker and escape the separating action.

**NOTE:** If the conditions require, the Primary shaker may need to be adjusted forward by the turnbuckle at each side.

- Adjust shaker hood to 1" clearance above shaker tines; More clearance in heavy vines.
- *Daily:* Check the bolts on the rubber shaker drive at the motor.
- *Weekly:* Grease shaker bearings, check tension on drive belts, and watch for loose set collars or bolts (*refer to following shaker timing belt alignment diagram*).

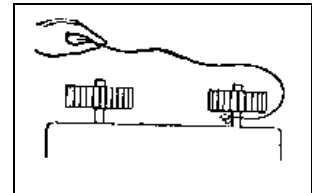
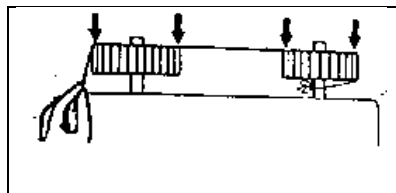
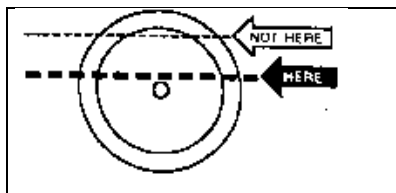

**CAUTION:** Do not pry or otherwise force the belt onto the sprockets, as this can result in permanent damage to the belt. For easy installation, reduce the center distance between the sprockets.

### 5 - 7a: Shaker Belt Tensioning Procedure

Note: this procedure is for determining the proper belt tension for belts labeled (RPP Plus).

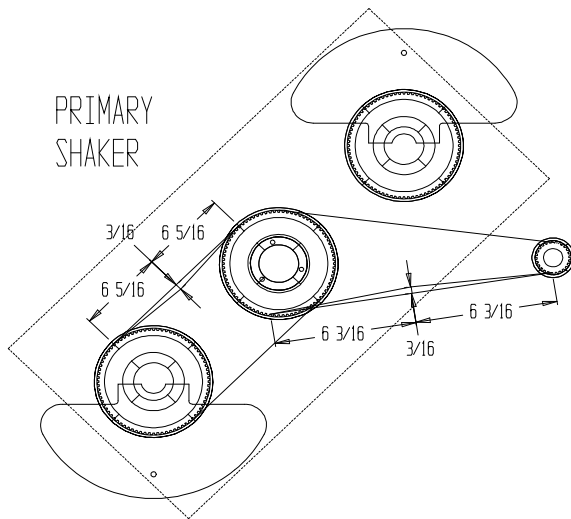

When belt replacement is necessary, refer to the Pik Rite service video for belt installation and weight timing procedures. Note that pulleys must be parallel. Misalignment causes uneven pressure on the teeth of the belt, uneven loading of the tensile member and extreme edge wear on the belt which can result in premature belt failure. Never pry or otherwise force belts onto pulleys as this can result in permanent damage to the belt.

Proper belt tension is chosen so as to avoid possible problems.

1. (Tooth Jump) assure that the belt is tensioned adequately to prevent tooth jump under the most severe load conditions that the drive will encounter.
2. (Extremely High Belt Tension) avoid extremely high tension which results in elevated noise levels and reduced belt and bearing life.

Getting started you will need a belt tension spring scale (Pik Rite Part # TL-470), a tape measure and a straight edge. Starting with one of the weight pulleys, position the weight in the box as to apply pressure to the belt and simulate belt load. At the center of the belt span, use your spring scale and measure the force to deflect the belt the dimension shown in the table below.

The drive belt should be measured on the bottom side of the belt. This is the torque side of the belt if the weights are spinning counterclockwise looking at the box. At the center of the belt span, use your spring scale and measure the force to deflect the belt the dimension shown in the table below.

#### **Weight Belts**

	Primary Shaker 35mm or 1 3/8" x 1280mm
Deflection using spring scale, in.	3/16
Force required for deflection, lb.	8-10 lbs.

#### **Drive Belts**

	Primary Shaker 35mm or 1 3/8" x 1280mm
Deflection using spring scale, in.	3/16
Force required for deflection, lb.	8-10 lbs.

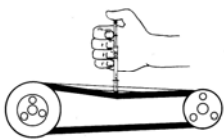

**Belt Tension Spring Scale,**  
Pik Rite Part # TL-470

## **5 - 8: Secondary Shaker**

Refer to Primary Shaker maintenance, section 5-7.

## **5 - 9: Debris Elimination System**

The Debris Elimination System etc. ...

- Check daily for tomatoes or dirt, both inside of and at the bottom of the fan housing.
- For peak efficiency, keep the housing and diffuser clean and smooth.
- Wash out the system with water periodically.

**CAUTION:** *Dirt build-up decreases the efficiency of the fan and cause vibration.*

- Watch out for build-up on the fan paddle assembly.
- Check the pipe-roller and scraper on top of the fan for dirt build up.
- Check the large debris belt to be sure it is turning freely.
- Clean the dirt build-up off of the top deflector hood.

## **5 - 10: Presort Belt and Elevation Conveyor**

The *pre-sort belt and elevation conveyor* ....

- Frequently clean and scrape dirt build-up from the surface of the belt.
- Check inside slider belt drive rolls. Especially observe the V-guides (inside of presort belt) and the grooves in the drive rolls.

**WARNING:** The belt must be adjusted and properly aligned on the V-guides or irreparable damage will be done to the belt. Do not over-tighten presort belt or it will cause tearing at the joint.

## **5 - 11: Hand Sort Belt**

The *hand sort belt* ....

- Frequently clean and scrape dirt build-up from the surface of the belt.
- Check inside slider belt drive rolls. Especially observe the V-guides (inside of presort belt) and the grooves in the drive rolls.

**WARNING:** The belt must be adjusted and properly aligned on the V-guides or irreparable damage will be done to the belt. Do not over-tighten presort belt or it will cause tearing at the joint.

## **5 - 12: Discharge Conveyor**

The *discharge conveyor* ...

- Check the lap splice belts daily.
- Keep belt running freely between the rollers.
- Check the basket sides.

**NOTE:** The discharge conveyor is designed so that it does not damage other components. If an operator accidentally bends the conveyor, it can be straightened out rather easily: simply pull it in the opposite direction that it was bent.

## **5 - 13: Electro-hydraulic Valve & Control**

The DO3 valve is located at the front of the machine. A standard machine consists of 8 portions. Starting from the top, they include the following:

U - Unload with inlet & outlet ports

#8 – Tongue

#7 – Outer Discharge

#6 – Middle Discharge

#5 – Bottom Discharge

#4 – Leveling

#3 – Inside Header

#2 – Outside Header

#1 – AHHC

The Machine is to be operated in *close center* mode only.

- A *check valve* in the inlet line permits the oil to flow through the valve in the correct direction. If the oil is flowing in the wrong direction, the valve will not work. A *high-pressure filter* in the inlet line removes dirt coming from the tractor. If the filter becomes clogged and oil bypasses the filter, a *bypass* (signified by a red pin on the top of the filter) pops up.

**NOTE:** In order to make the harvester compatible with any brand of tractor\*, Pik Rite designs the harvester for hydraulic operation in the open center mode. This allows the farmer to use any brand of tractor\* without the complications of changing the harvester valve body when switching tractors. The Pik Rite Tomato Harvester requires the following:

- Minimum of 12 gallons per minute and 2500 PSI
- Maximum of 18 gallons per minute and 3000 PSI

**CAUTION:** *The backpressure of the return line should not exceed 200 PSI*

## CONNECTING AN ORBITAL HYDRAULIC MOTOR

Connecting a hydraulic motor is identical to connecting the hydraulics to the Pik Rite Tomato Harvester.

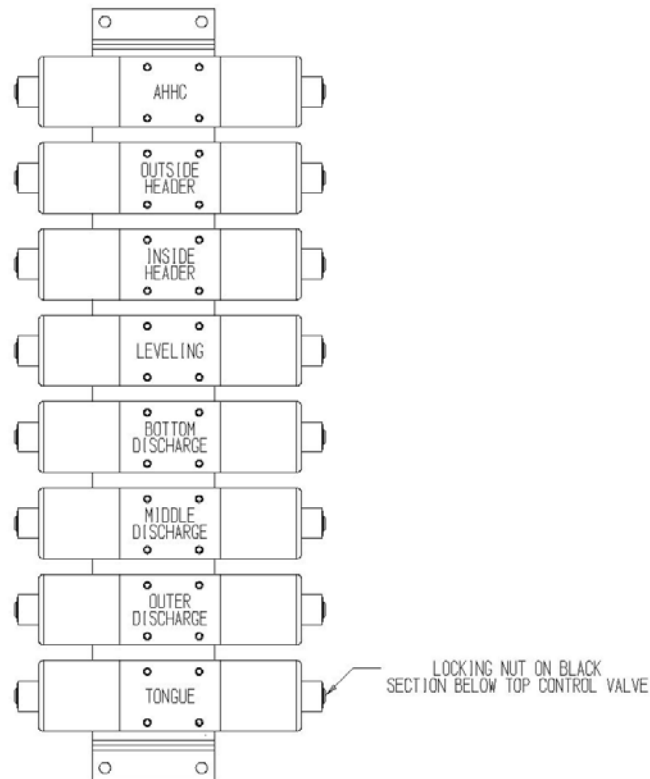

### Cylinder Speed Adjustment:

To adjust cylinder speed, follow these steps:

1. Loosen locking nut (shown above).
2. To *decrease* cylinder speed: Turn adjuster screw (shown above) *clockwise* until desired speed is achieved.
3. To *increase* cylinder speed: Turn adjuster screw *counterclockwise* until desired speed is achieved.

**CAUTION:** *If your harvester is equipped with an **automatic leveler**, the level control speed will need to be kept slow enough to keep the automatic leveler from over-adjusting. (When the leveling cylinder lifts and lowers the harvester while it is sitting still, the automatic leveler is over-adjusted.)*

## **5 - 14: Air Compressor (If Equipped with Air System)**

In addition to controlling the discharge, the operator must listen for a loud hiss at regular intervals and the red indicator light on the top of the header to go off, indicating that the air dryer is unloading. The unloading process is based on changes in air pressure. Each time the air reservoir reaches peak pressure, the air dryer back flushes. At the same time, the air compressor head closes and stops pumping air until the pressure drops in the reservoir, calling for more pressure. If the air dryer does not unload, it means that the air pressure is not reaching peak pressure. This may mean a compressor problem or an air leak. This in turn may affect the electronic sorter's efficiency.

To check your air compressor, follow these steps:

1. Install a valve and gauge to the air reservoir.
2. Keep the valve open and run the PTO at 500 RPM
3. Close the valve while observing the pressure gauge. Note the seconds elapsed and peak pressure.

### **AIR SYSTEM MAINTENANCE**

- **Rule # 1: KEEP AIR COMPRESSOR COOL!**  
**CAUTION:** *Dust buildup may cause overheating.*
- **Check air compressor air filter daily.** Filter may be cleaned using warm water and a mild detergent. Replace filter as needed. Assure Filter is seated properly before installing Filter Cover.
- Check air compressor Suction Hoses for kinks or clogs.
- Check air compressor *oil* daily. Pull out the dipstick carefully so that no dirt enters.
- Change oil every 100 hours of running. Refill with #30 *non-detergent* or synthetic air compressor oil.
- Air compressor light cycles with loading and unloading of the air compressor. This allows the operator to observe how hard the air compressor is working. If the light is on a lot this indicates that the electric sorter is working very hard or there is an air leak.  
**CAUTION:** *The system can overheat.*

### **CHECK AIR DRIER**

#### **Air Drier**

Note: Maximum inlet air temperature is 160°F. Temperatures above 160°F entering the drier will cause diminished performance and may cause internal damage to the drier.

1. Operation  
At cutout pressure (listen for “pumping” near compressor, and watch for

- indicator light to go off. The light is on when the air compressor is pumping air) the drier purge valve opens and immediately expels a large volume of air, followed by a slow flow of air lasting approximately (30) thirty seconds.
2. Desiccant Canister
    - a. Use proper filter wrench near end of canister
    - b. Replace every (4) seasons. (Check and determine: dirty/water drips runs out/conditions at harvest.)
  3. Coalescing Filter (Mixing Filter)

Look inside filter. If the grated support is covered with carbon or other contamination, the filter needs to be replaced. Note: in normal operation filter will become saturated with oil and will look that way, but is fully operational. As preventive maintenance the coalescing filter should be replaced every 3600 operating hours.
  4. Tell tale signs:
    - a. Check filters every season or more.
- At beginning and End of Session: Assure Air Tanks are drained of excess moisture and flush air system with “Truck Air-Line Dryer / Antifreeze” liquid.
  - Check Air Governor Setting: 100 PSI (In to decrease, Out to increase)

**ALWAYS RELEASE AIR PRESSURE before servicing!**

## **AIR SYSTEM ANALYZING PROCEDURE**

To analyze the air system of your air compressor, follow these steps:

1. Observe the approximate percentage of the presort belt fill as well as the approximate percentage of green tomatoes. These observations tell you how hard the sorter is working).
2. Observe the number of seconds between air dryer cycles. Each cycle ends with a hissing sound (compressed air discharging).
3. Observe the approximate air compressor temperature on top of all four heads. Place the palm of your hand on the compressor to feel whether all four locations are about the same temperature. A similar temperature indicates that all 4 pistons are pumping properly.
4. **When the PTO is off and machine is stopped**, observe the coupling device. Look for loose set screws and misalignment.
5. Observe the air compressor filter cleanliness.

6. Observe the air compressor unloading cycle. With the filter removed, place your ear near the filter base and listen for a change in the pumping sound at the same time that the air dryer cycles.
7. Be sure that the air pressure on FRL is 65 PSI. *[Grademaster]*  
**CAUTION:** *The air pressure must not drop below 45. Such a drop may indicate a faulty governor.*
8. Listen for air leaks;  
**CAUTION:** *Leaks cause air compressors to overheat.*

### **5 - 15: Vine Chopper (If Equipped)**

The bolts and flails of the vine chopper are wear items and should be checked or replaced as follows:

- Check bolts and flails daily for excessive wear
  - If part(s) is worn 50% or more, replace the part(s) immediately
  - Replace bolts and flails after each season or sooner if necessary
- CAUTION:** Keep away from Vine Chopper when running.

### **5 - 16: Suspension**

Grease the pivot points and steering pivot points daily.



## 5 - 17: Lubrication and Oils

### 1. Grease Points and Roller Chain Lubrication

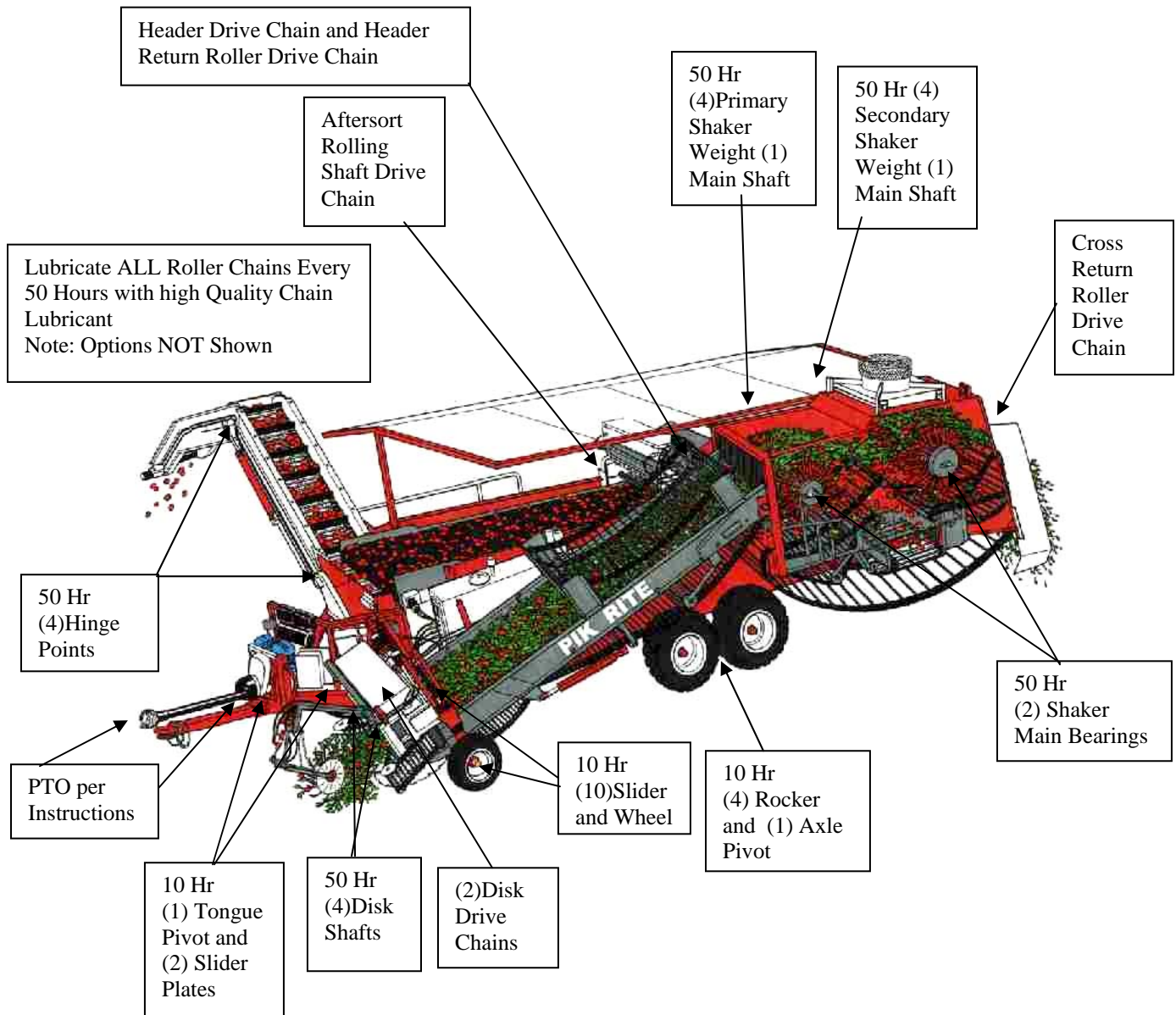

## 2. Machine Hydraulic Oil and Maintenance

### Oil Specification

**NOTE:** *Viscosity and cleanliness are the most important items to consider in maintaining long life in the hydraulic system.*

- Pik Rite recommends \*Hydrocarbon-based oils that will maintain a viscosity of 80-100 SUS (15-20CST) at operating temperatures.
- Start-up viscosity must not exceed 7500 SUS (1600 CST) and also must maintain \*ISO cleanliness levels of 19/17/14 or better.

### 1. Viscosity Requirements

Definitions:

- *Viscosity* is the measure of how a fluid resists flow.
- *Operating temperature viscosity* is the temperature at which oil does its work.

When viscosity *increases*, fluid becomes *thicker*, as the temperature *decreases*, fluid becomes *thinner*. This may cause problems.

**CAUTION:** *A viscosity must be selected that will flow freely and yet be thick enough to lubricate the moving parts in the pump and motors.*

- Pik Rite Harvesters are shipped with ISO grade 46 with viscosity index of a minimum of 90. Additives need to include rust and oxidation inhibitors and foam depressant. This is good grade oil for average daytime temperatures at harvest time.
- Any good quality, ISO, grade 46 oil or SAE 10 motor oil is acceptable, providing that the viscosity is within specification at operating temperatures and start-up temperature.
- If average daytime temperatures are above 95 degrees F and the machine's hydraulic oil temperature rises to 180 degrees F, Grade #46 viscosity may be too low. If this oil is too thin (viscosity too low), oil with ISO grade of 68 or SAE 15 may need to be installed.
- Mixing thicker oil (higher viscosity), such as SAE 30 or ISO 100, is a means of increasing the operating viscosity. After this is done, an oil sample should be sent to a lab for testing to insure proper viscosity.

**NOTE #1:** ISO standards allow up to 10% variation from a specification. An ISO grade 46 hydraulic oil can actually be 42 or 50 and be considered a grade 46.

**NOTE #2:** When using motor oils, non-detergent oil is preferred; however, detergent oil is not harmful. The detergents will tend to hold or suspend any moisture in the oil.

Many hydraulic oils include in the additives a demulsifier which will encourage the water to separate and be drained off the bottom of the reservoir.

## 2. Cleanliness Requirements

- The components on the harvester must have an \*ISO cleanliness level of 19/17/14. This means that there must be fewer than 150 parts per milliliter in the 5 micron or greater size and fewer than 200 parts per milliliter in the 15 micron or greater size. (A human hair is about 70 microns in diameter and talcum powder is 10 microns.)
- Filters must maintain this level of cleanliness. Any filter may be used providing that the above results are achieved. The hydraulic oil must be "clear" and not "milky". A "milky" looking oil is a good indication that excessive water is present.
- To determine cleanliness level, send oil samples to a lab for analysis (a common procedure).

\*International Standards Organization

The most accepted fluid system contamination level designation in use today is the ISO "Solid Contamination Code" (ISO #4406). This format plots cleanliness levels (ISO Codes) based on particle counts at 5 and 15 micrometers per 100 ml of fluid under evaluation. An additional count at 2 microns is under review by ISO and likely to be adopted soon. Pik Rite has accepted this as a standard as of 4/15/95.

\*Hydrocarbon based

Hydrocarbon- (petroleum) based hydraulic fluids and straight oils are the most common fluids for hydraulic systems. The difference between a hydrocarbon-based hydraulic fluid and straight oil is generally the additive. Some automotive or crankcase motor oils with the proper additives can be acceptable.

## 5 - 18: Hydraulic Pump

The Hydraulic system can be diagnosed and analyzed with some basic information. A phone call to a service man with this information may prevent breakdowns or permanent damage to the machine.

### A. Analyzing Hydraulic Pump Pressures

**NOTE:** Hydraulic pump pressures should be analyzed at operating temperature.

Observe and record the following:

1. Approximate outside temperature at time of tests \_\_\_\_\_
2. Approximate operating PTO RPM \_\_\_\_\_
3. Operator's customary engine speed when engaging the PTO \_\_\_\_\_
4. Machine's hydraulic oil temperature \_\_\_\_\_
5. Return filter pressure (located on filter base) \_\_\_\_\_
6. Machine's hydraulic pressures while running in the field \_\_\_\_\_
7. Stall-out pressures of each pump section (relief valve setting) \_\_\_\_\_

Observe and record the following:

**Left Pump**

**Section #1:** Port located top front of pump.....:  
Average Pressure\_\_\_\_ Highest Pressure\_\_\_\_ Stall out Pressure\_\_\_\_

**Section #2:** Port located top-middle of pump:  
Average Pressure\_\_\_\_ Highest Pressure\_\_\_\_ Stall out Pressure\_\_\_\_

**Section #3:** Port Located on the top-rear of pump:  
Average Pressure\_\_\_\_ Highest Pressure\_\_\_\_ Stall out Pressure\_\_\_\_

**Right Pump**

**Section #1:** Port located top-front of pump:  
Average Pressure\_\_\_\_ Highest Pressure\_\_\_\_ Stall out Pressure\_\_\_\_

**Section #2:** Port located top-middle of pump:  
Average Pressure\_\_\_\_ Highest Pressure\_\_\_\_ Stall out Pressure\_\_\_\_

**Section #3:** Port located top-rear of pump:  
Average Pressure\_\_\_\_ Highest Pressure\_\_\_\_ Stall out Pressure\_\_\_\_

**NOTE:** Stall out pressures can be determined by stalling a motor in the section tested.

**CAUTION:** Before attempting to stall out any motor, disengage PTO and turn the Flow Control to off position.

- Use a pipe wrench on the motor coupler, start PTO at low RPM, and open Flow Control slowly.
- Observe the pressure, and record it.
- Call or send this information to a Pik Rite service technician. This information will help in determining the condition of the hydraulic system.

**B. Setting Pressures on Hydraulic Relief Valves**

- Oil temperature should be approximately 100°.
- PTO speed should be approximately 900 RPM.
- Install the P valve gage on the various test ports located at the front of the harvester.
- Pressures are Factory Set; Consult Pik-Rite/Dealer before resetting.

### ***Left pump***

#### **Section #1:**

Stall out the transfer drive motor using a pipe wrench on the motor coupler. System pressure should be at 2000 PSI.

#### **Section #2:**

Stall out the primary or secondary shaker weight. Jam a piece of wood (2X4) inside the weight box to stop the weight rotation. (It is best to have the shaker rotation off during this process). System pressure should be at 2300 PSI.

#### **Section #3:**

Stall out the Discharge Conveyor or Aftersort Conveyor by using a pipe wrench on the motor coupler. System pressure should be 2300 PSI.

### ***Right pump***

#### **Section #1:**

Stall out the Debris Fan. Jam a 2X4 or piece of wood in the Fan Paddle housing. System pressure should be at 2600 PSI.

Remove the wood and stall out the vine chain using a pipe wrench on the motor coupler. Check the pressure at the same test port as the debris fan. HOWEVER: Adjust the pressure relief at the flow control to 1600 PSI. This setting protects the vine chain in the event it is jammed in normal operations.

#### **Section #2:**

Stall out the Cross Conveyor using a pipe wrench on the motor coupler. System pressure should be 2000 PSI.

#### **Section #3:**

Stall out the Disk Motors. Use a vice grip and clamp both disks at the V-overlap at the point the V-disks are turning in. System pressure should be at 3000 PSI.

Remove the vice grip and install a pipe wrench on the header chain drive motor coupler. Check the pressure at the same test port as the shaker test. HOWEVER: Adjust the pressure relief at the flow control to 2300 PSI. This setting protects the Header chain belt in the event it is jolted with a rock or debris in the normal operations.

## C. Analyzing Hydraulic Pump Flows

Install a flow meter at the pump and record pump output (GPM) at different pressures; i.e. 1500 PSI, then 2500 PSI, etc., note the GPM's at each pressure setting.

**NOTE:** Pik Rite service personnel have flow meters.

**NOTE:** Test should be performed with PTO at approx. 900 RPM and oil temperature at 100 degrees or more and with flow controls wide open on the components being checked.

### 5 - 19: Checklist

**NOTE:** *Owner / operator may add to this list at his own discretion*

#### Daily

- ▶ For all safety shields/decals in place, and harvester is in safe working condition including lights and horn
- ▶ Grease all (10) hour grease points
- ▶ Air compressor oil / SAE 30 non detergent
- ▶ Air compressor filter
- ▶ Tires
- ▶ All belted chain rollers for rotation, and excessive wear
- ▶ Bent belted chain rods
- ▶ Wear of vibrator rollers
- ▶ Shaker belt alignment, tension and weight timing (primary & secondary)
- ▶ Weight belt pulley teeth clean and free of debris
- ▶ Shaker fingers, tips and broken
- ▶ Fins on oil cooler for cleanliness
- ▶ Filters on enclosure vent fan (if equipped)
- ▶ Flat conveyor belts for tension, alignment/wear (edges and v-guide)
- ▶ Taper bushing on air compressor driver pulley
- ▶ Roller chain sprockets set screws/ taper bushing secure, also assure key is in place
- ▶ Oil level and temperature in oil reservoir
- ▶ Assure all points such as belted chains etc. are not rubbing side panels, shields or other that could cause premature wear
- ▶ Vine chopper bolts and flails for excessive wear, replace if necessary (if equipped)

#### Weekly

- ▶ Grease all (50) hour grease points
- ▶ Lubricate roller chains (when chains are warm if possible), disk drive (2) header drive (1) header return roller drive (1) cross return roller drive (1) aftersort rolling shaft drive (1) and other options if equipped

- ▶ All tire pressures
- ▶ Wear on header return roller (adjust hold up rollers on belted chain to prevent wear)
- ▶ Alignment of belted chain and sprockets within the conveyor
- ▶ Tension and wear of roller chains
- ▶ Shaker drive coupler bolts, and rubber donut wear/alignment
- ▶ Taper lock bolts on shaker center shafts
- ▶ Center rocker bolts (center of big wheel rockers) (2) places
- ▶ Tension on air compressor drive belts
- ▶ Adjustment on header disk scrapers above and below disks
- ▶ Wear of header disks
- ▶ Alignment of motor drive couplers (non solid/rigid)
- ▶ Tighten disk motor bolts



### Yearly

- ▶ Inspect and lubricate all wheel bearings
- ▶ **Recheck weekly and extended season list**
- ▶ Replace hydraulic oil filters (2 oil tank, 1 breather for oil tank, 1 high pressure for cylinder valve) hydraulic oil sample test kits are available if desired
- ▶ Check pressure and flow of the four pump sections
- ▶ Air compressor service; change oil, and (check condition of filter, replace if needed)
- ▶ Air dryer service, check desiccant canister, coalescing filter, and valve
- ▶ Condition of belted chains
- ▶ Check all roller chain and belted chain sprockets rubbing, wearing, etc)
- ▶ Clean and paint any metal that has been rubbed or scuffed
- ▶ Replace vine chopper bolts and flails (if equipped)



### Sorter

- ▶ Clean glass
- ▶ All fingers operating
- ▶ No debris in sight area
- ▶ Lubricating oil level and water drained from separator
- ▶ Proper oil drops per minute / 6-8 drops per minute
- ▶ Proper air pressure in normal working conditions 60psi grademaster



### Keep These Areas Clean

- ▶ Front header chain area (cross pieces)
- ▶ Wheel and rocker area
- ▶ Shaker chamber including inside of panels, and header delivery area onto transfer chain
- ▶ Vine chain rollers/plastic shields area around secondary shaker
- ▶ Debris fan intake (front and rear), paddles, and inside of hood
- ▶ Elevation hold down rollers and plastic shields
- ▶ Inside of panels on both sides of presort belt
- ▶ Under presort belt area, and rear aftersort rolling shaft
- ▶ Discharge basket area



### Extended Season Maintenance / 300+ Hours or Adverse Conditions

- ▶ Belted chain con rods, clips, bolts and rivets
- ▶ Wear on roller chain, and belted chain sprockets for wear
- ▶ Bar cleaner sprockets for wear
- ▶ Maintain shaker weight bearing bolts for tightness
- ▶ Color or dirt sorter fingers for wear and loose finger bolts
- ▶ All motor drive couplers
- ▶ Steel/rubber belted chain return rollers for wear
- ▶ Aftersort belt lacer and lacer pin for wear



### End of Season Maintenance

- ▶ Flush air system with “air brake system anti-freeze and rust guard” (also at season start-up)
  - ▶ **Release air system pressure, and drain moisture from air tank!!!**
  - ▶ Lubricate all rollers with moisture displacing lubricant or a good quality penetrating oil
  - ▶ Remove color sorter electronic unit (if equipped), and contact your Pik Rite dealer for winterization schedule
-



## **6 - 01: Header Height Set up procedure**

Please consult Pik Rite before making any adjustments.

**At power up, you may rotate the left side control # to select the variable displayed: Ain (A input), Aot (A output), Bin (B input) or Bot (B output). These are just for displaying what the control is receiving(input) from the rotary sensor, or sending(ouput) to the valve.**

**To enter set-up mode, rotate right side control \* ; the display will show the settings sequentially: AHI, AJg, ALO, AUP, Adn, Adb, Ain, BHI, BJg, BLO, BUP, Bdn, Bdb, Bin, db, dF, in, di and SA. When you reach the setting that you want to modify, rotate # up or down to the desired value. To modify another setting, rotate \* and repeat. USE CAUTION The Driver is fully functional during the set-up procedure with any adjustments effective immediately (except the input range selection that becomes effective only after saving). In order to write the new settings in the memory and return to normal mode of operation, rotate \* until the display shows SA and then rotate # one continous full turn left or right . If you do not want to keep the new settings, simply power down without saving.**

### **Description of Settings**

<b><u>SETTINGS</u></b>	<b><u>FUNCTION</u></b>
	<b><u>THE A SETTINGS ARE FOR THE DOWN DIRECTION ON THE CYLINDERS</u></b>
AHI-	HIGHEST AMPERAGE OUTPUT SENT TO THE SOLENOID VALVE, THIS WILL AFFECT THE MAXIMUM POSSIBL SPEED OF THE VALVE
Ajg-	NOT USED, DO NOT ADJUST
ALO-	THIS IS THE LOWEST AMPERAGE THAT THE VALVE WILL SEE, THIS WILL GREATLY AFFECT THE SPEED AT WHICH THE VALVE STARTS TO MOVE, THE HIGHER THE SETTING THE MORE RESPONSIVE THE VALVE IS
AUP-	NOT USED, DO NOT ADJUST
Adn-	NOT USED, DO NOT ADJUST
Adb-	THIS IS THE LAG IN SECONDS FROM THE A TO THE B SIDE OF THE VALVE

Ain-	THIS SETTING IS USED IF WE ARE ONLY CONTROLLING ONE DIRECTION, THIS WILL NOT BE USED AND SHOULD BE SET TO 000
	<u>THE B SETTINGS ARE FOR THE UP DIRECTION ON THE CYLINDERS</u>
BHI-	HIGHEST AMPERAGE OUTPUT SENT TO THE SOLENOID VALVE, THIS WILL AFFECT THE MAXIMUM POSSIBL SPEED OF THE VALVE
BJg-	NOT USED, DO NOT ADJUST
BLO-	THIS IS THE LOWEST AMPERAGE THAT THE VALVE WILL SEE, THIS WILL GREATLY AFFECT THE SPEED AT WHICH THE VALVE STARTS TO MOVE, THE HIGHER THE SETTING THE MORE RESPONSIVE THE VALVE IS
BUP-	NOT USED, DO NOT ADJUST
Bdn-	NOT USED, DO NOT ADJUST
Bdb-	THIS IS THE LAG IN SECONDS FROM THE B TO THE A SIDE OF THE VALVE
Bin-	THIS SETTING IS USED IF WE ARE ONLY CONTROLLING ONE DIRECTION, THIS WILL NOT BE USED AND SHOULD BE SET TO 000
db-	THIS SETTING IS USED IF THE SIGNAL FROM THE ROTARY SENSOR IS LOST, THE VALUE IS THE PERCENTAGE OF MOVEMENT REQUIRED TO RELAY A SIGNAL TO THE VALVE
dF-	THIS IS THE SAMPLES PER SECOND THAT THE CONTROL IS SEEING FROM THE ROTARY SWITCH
in-	THIS IS THE INPUT SIGNAL FROM THE ROTARY SWITCH, WE USE 010 WHICH IS 10V
di-	NOT USED, DO NOT ADJUST
SA-	USED TO SAVE SETTINGS AFTER AN ADJUSTMENT HAS BEEN MADE

## Factory Settings

<u>SETTINGS</u>	<u>VALUES</u>	<u>DESCRIPTION/FUNCTION</u>
AHI-	2.8	High output in AMPS
Ajg-	0	
ALO-	0.92	Low output in AMPS
AUP-	0	Dwell time in seconds
Adn-	0	Dwell time in seconds
Adb-	0.3	lag in seconds from A to B
Ain-	0	
BHI-	2.8	High output in AMPS
BJg-	0	
BLO-	0.92	Low output in AMPS
BUP-	0	Dwell time in seconds
Bdn-	0	Dwell time in seconds
Bdb-	0.1	lag in seconds from B to A
Bin-	0	
dF-	150	Pulses per second of control output/PWM
db-	2	
in-	10	In/out signal from the rotary sensor, 5= 5 volt input
di-	123	
SA-	SAVE	